

(Bad copy)

# SQ-10

## SERVICE MANUAL

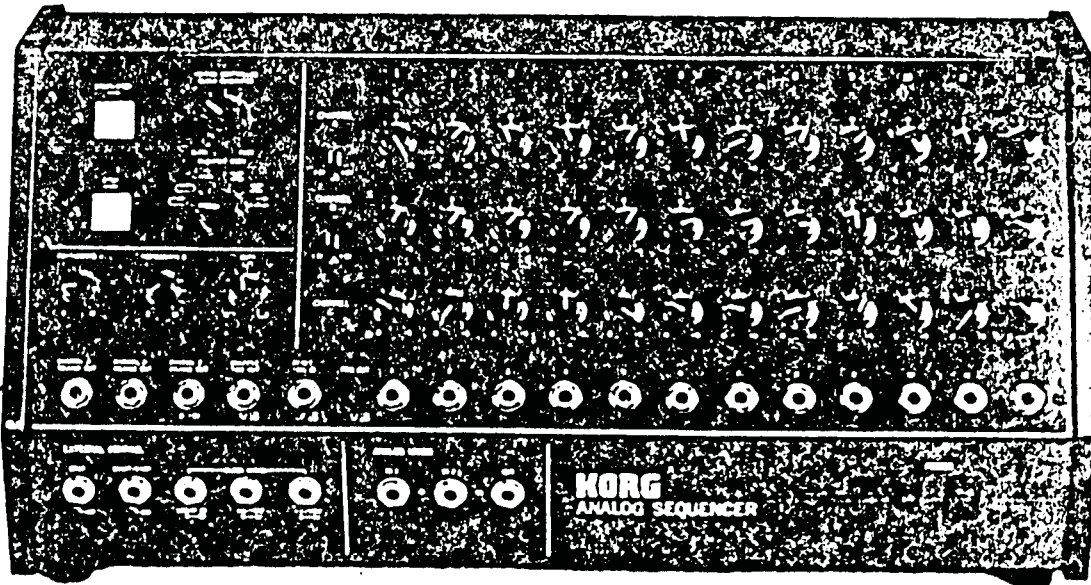

KEIO ELECTRONIC LAB., CORP.  
TOKYO, JAPAN

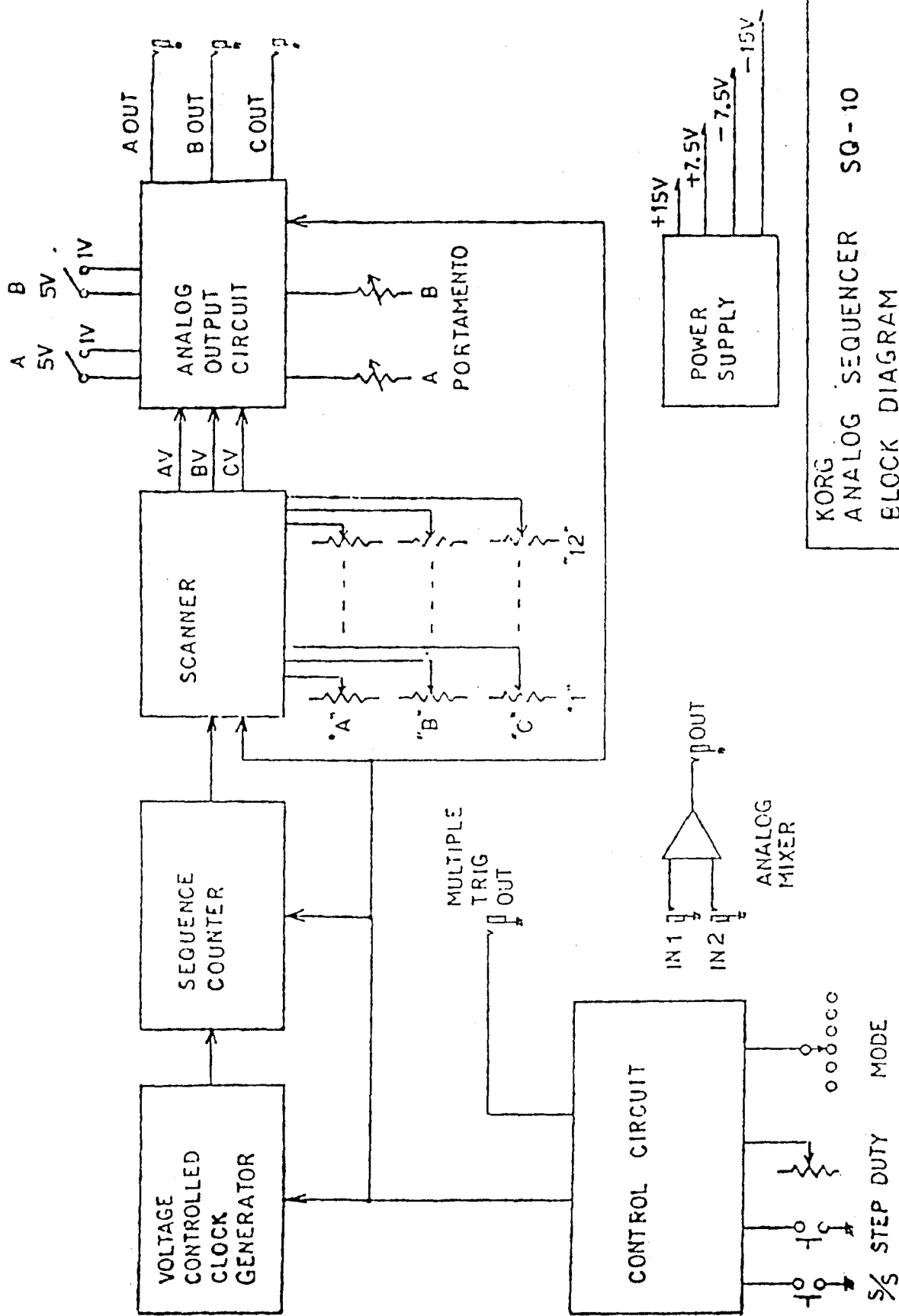

KORG  
ANALOG SEQUENCER SQ-10  
BLOCK DIAGRAM





Checking and Adjustment

Power Check & Adjust

1. +15V; Should be 14.4V~15.6V.
2. -15V; Should be -14.4V~-15.6V.
3. +7.5V; Adjust VR46 to 7.50V.
4. -7.5V; Adjust VR47 to -7.50V.

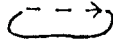
Function Test -- Standard -- Connect MS-10 (fig 1)

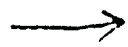
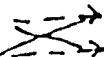
Set MS-10 and SQ-10 controls (fig 2)  
(fig-3)

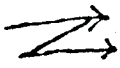

No.	Mode Rotary switch	Check
2.		Clock LED flashes on and off.
3.		'12' LED turns on first. Then 1 and 2 each time step button is pressed, so the sequence goes 12, 1, 2. A and B LED's do not turn on in this mode.
4.		LED's 1 through 12 should be off at first. When S/S switch is pressed, sequence goes 1, 2, ..., 12, 1, 2, ... When S/S switch is pressed again, LED's go out. A and B do not light.
5.		LED's 1 through 12 should be off at first. When you turn on the S/S switch, the sequence should automatically advance 1, 2, ..., 12... and then stop after one time, If you press the S/S switch between 1 and 12, the sequence should stop. A and B do not turn on.
6.		B and 12 are on at first. A and 1 turn on when you first press the Step switch. Press it again for 2...12; again for B 1...12; and again for A 1...
7.		A and B and 1 through 12 should all be off at the beginning. When you press the S/S switch, the sequence should go A 1...12, B 1...12, A 1... automatically. Press the S/S switch again to stop.

8.  At the beginning A and B and 1 through 12 should all be off. Press the S/S switch and there should be a single cycle of A 1...12 and B 1...12. Then it should stop. It should also stop if you press the S/S switch while the LED's are changing.

Function Test (2)

- O means the phone plug connected to the MS-10 CV IN.
- ⊗ means the phone plug connected to the opposite side (open).

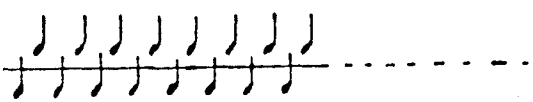
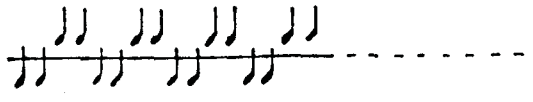
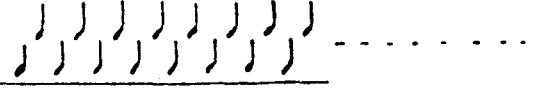
sa-10 Check 2/4

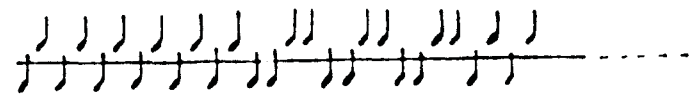
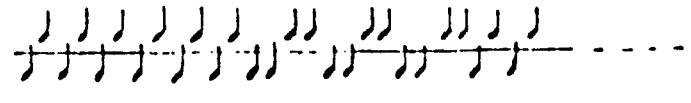
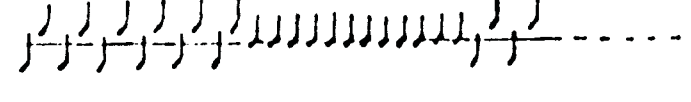
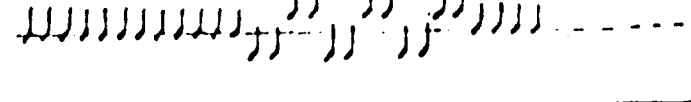

NO	MODE Rotary SW	(OUTPUT)			Musical interval
		A	B	C	
9		O			
10			O		
11				O	
12		O			
13			O		
14		O	⊗		
15		⊗	O		

OUTPUT CHECK



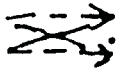

NO.	1 <sup>st</sup> Step VR 3.1	MODE	5V - 1V <sub>3W</sub>		Digital Volt Mtr			Measure STEP	Limit	
			A	B	A	B	C			
28	"1" A B C		5V	↑	○			"1"	+4.90 ~ +5.10 V	
29			1V		5V	○			"1"	+0.95 ~ +1.05 V
30						○			"1"	+4.90 ~ +5.10 V
31					↓		○		"1"	+0.95 ~ +1.05 V
32				1V			○		"1"	+4.90 ~ +5.10 V
33					↑			○	"1"	+4.85 ~ +5.15 V
34				5V	5V	○			"A" "1"	+4.85 ~ +5.15 V
35						○			"B" "1"	-4.85 ~ -5.15 V
36		"1" A B C				○			"1"	-4.90 ~ -5.10 V
37						○			"1"	-4.90 ~ -5.10 V
38							○		"1"	-0.10 ~ +0.10 V
39						○	"1"	-0.10 ~ +0.10 V		

○ Digital voltmeter to measure the phone jack

### Function Test (3)

No.	Item	Check
16	Portamento-A	Portamento effect should only show up in the channel A output when you turn up this knob.
17.	Portamento-B	Portamento should only show up in the B channel output.
18.	Duty	Should get shorter when knob is turned counter-clockwise. Should get longer when turned clockwise.
19.	Reset, Trig Out (1~11)	Connect RESET <sup>TRIG</sup> IN jack to each of TRIG OUT jacks 1 through 11 in turn, and see that the sequence returns to 1 after reaching the proper step. Disconnect after check.
20.	Trig Out (12)	With TRIG OUT 12 connected to the MS-10 TRIG IN jack, see that there is only a sound produced at the 12th step in a sequence. Disconnect after check.
21.	Step (jack)	Set mode to  . Connect MS-10 momentary switch to STEP jack and see that steps advance when you press the MS-10 switch. Set mode back to  and disconnect after check.
22.	Start/Stop (jack)	Connect MS-10 momentary switch to S/S jack,

and see that the MS-10 switch will turn the S/S on and off.  
Disconnect after check.

23. Linear In      Connect MS-10 control wheel  out to  
                                 LINEAR IN jack, and see that the clock  
                                 speed changes with input voltage. It should  
                                 get faster toward +5V. Disconnect after check.
24. x2/V            Connect MS-10  out to x2/V jack, and see  
                                 that clock speed changes with input voltage.  
                                 Speed increases towards +5V. Disconnect  
                                 after check.
25. +2/V            Connect MS-10  out to +2/V jack, and see  
                                 that clock speed changes with input voltage.  
                                 Speed should decrease toward +5V. Disconnect  
                                 after check.
26. Clock            Turning the CLOCK knob all the way counter-  
                                 clockwise should slow down the cycle 10sec ~ 40sec.  
                                 Turning the knob clockwise should speed up the  
                                 clock.
27. Analog            The sum of IN 1 and IN 2 voltages should  
    Mixer            appear in the OUT voltage.  
                                 For example: Connect MS-10  out to IN 1;  
                                 Connect SQ-10 multiple trigger out to IN 2;  
                                 Connect MS-10 CV IN to OUT.

Multiple trigger signal should modulate pitch of note  
when keyboard is played (or momentary switch is pressed)  
on MS-10. Changing IN 1 input voltage (from control wheel)  
will vary entire pitch.

FREQ CV IN

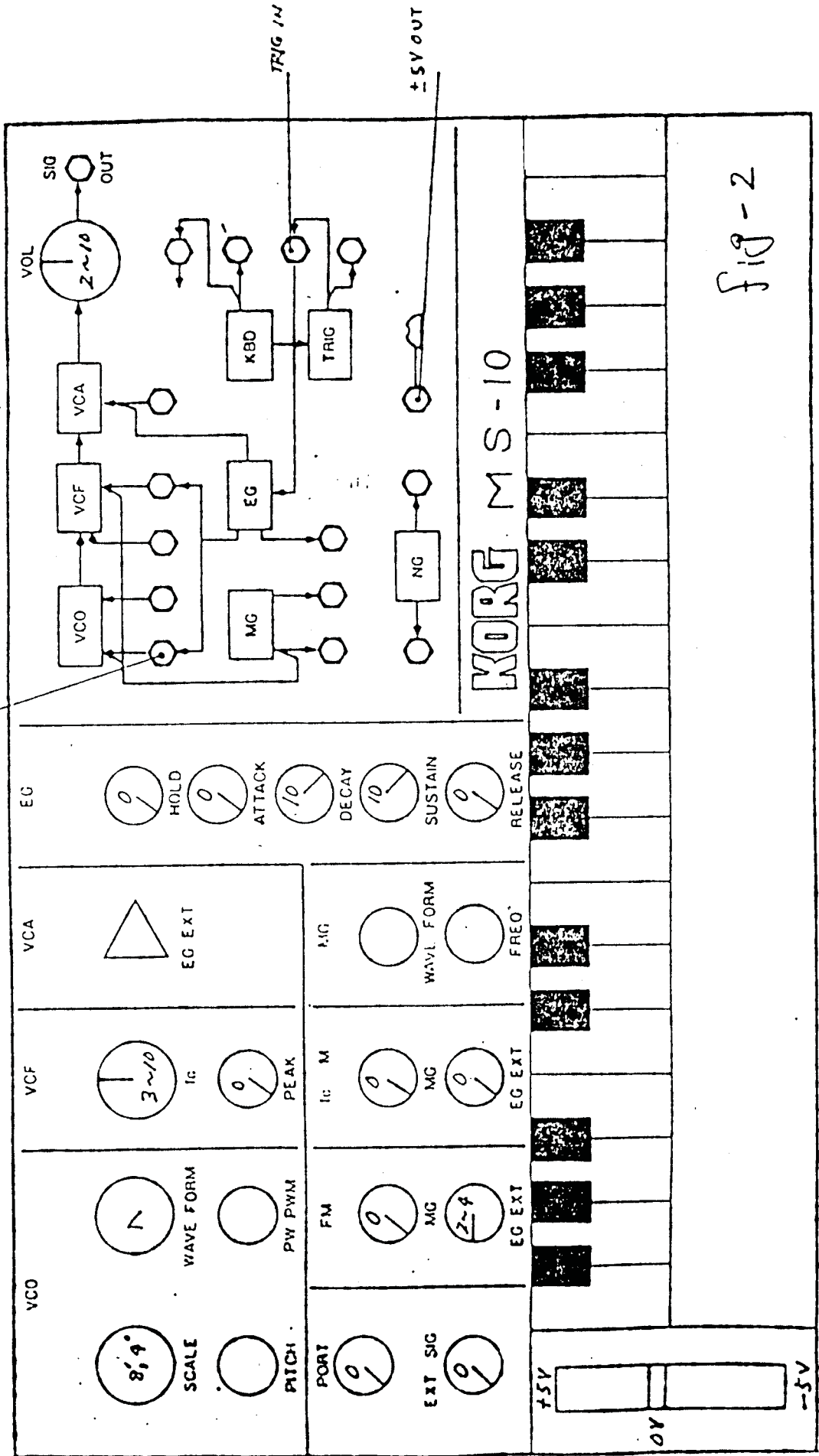
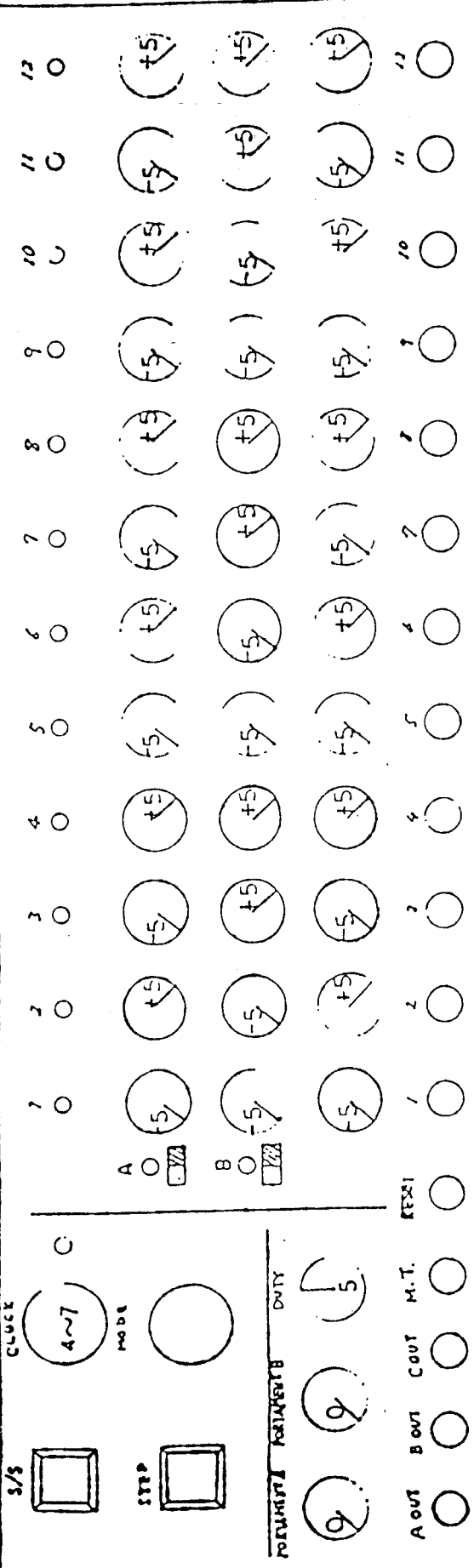

FIG-2





# KORG ANALOG SEQUENCER

fig-3

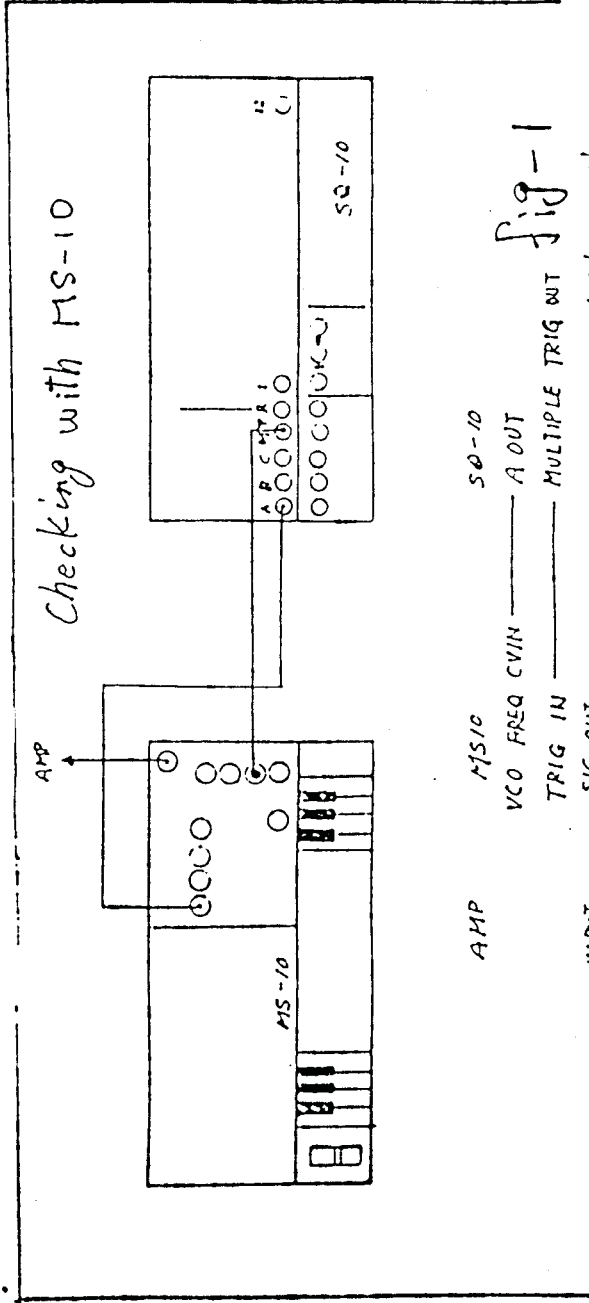
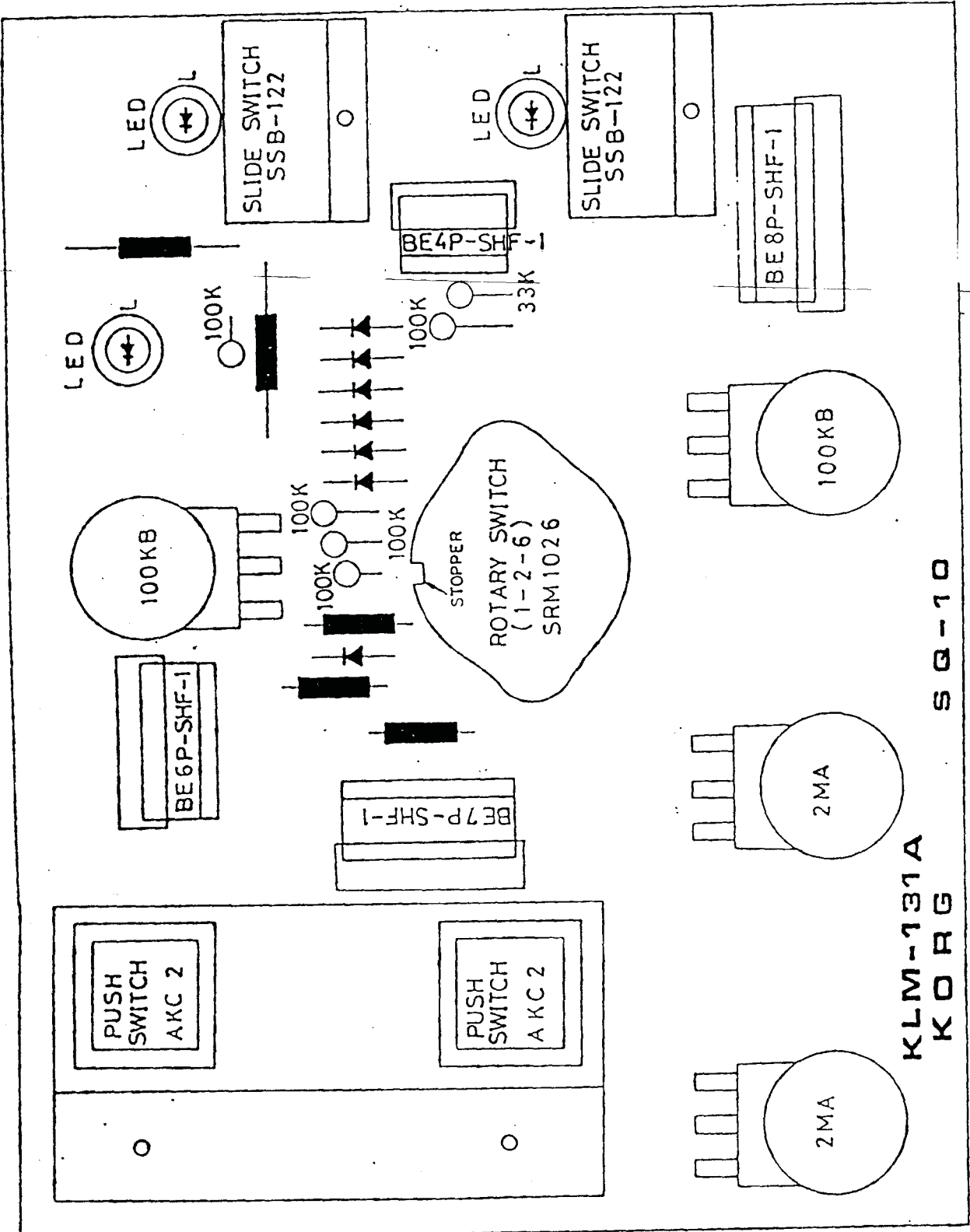

fig-1

See other chart for MS-10 control settings

452



KLM-131A  
KORG SQ-10

SQ 10 KLM-132C

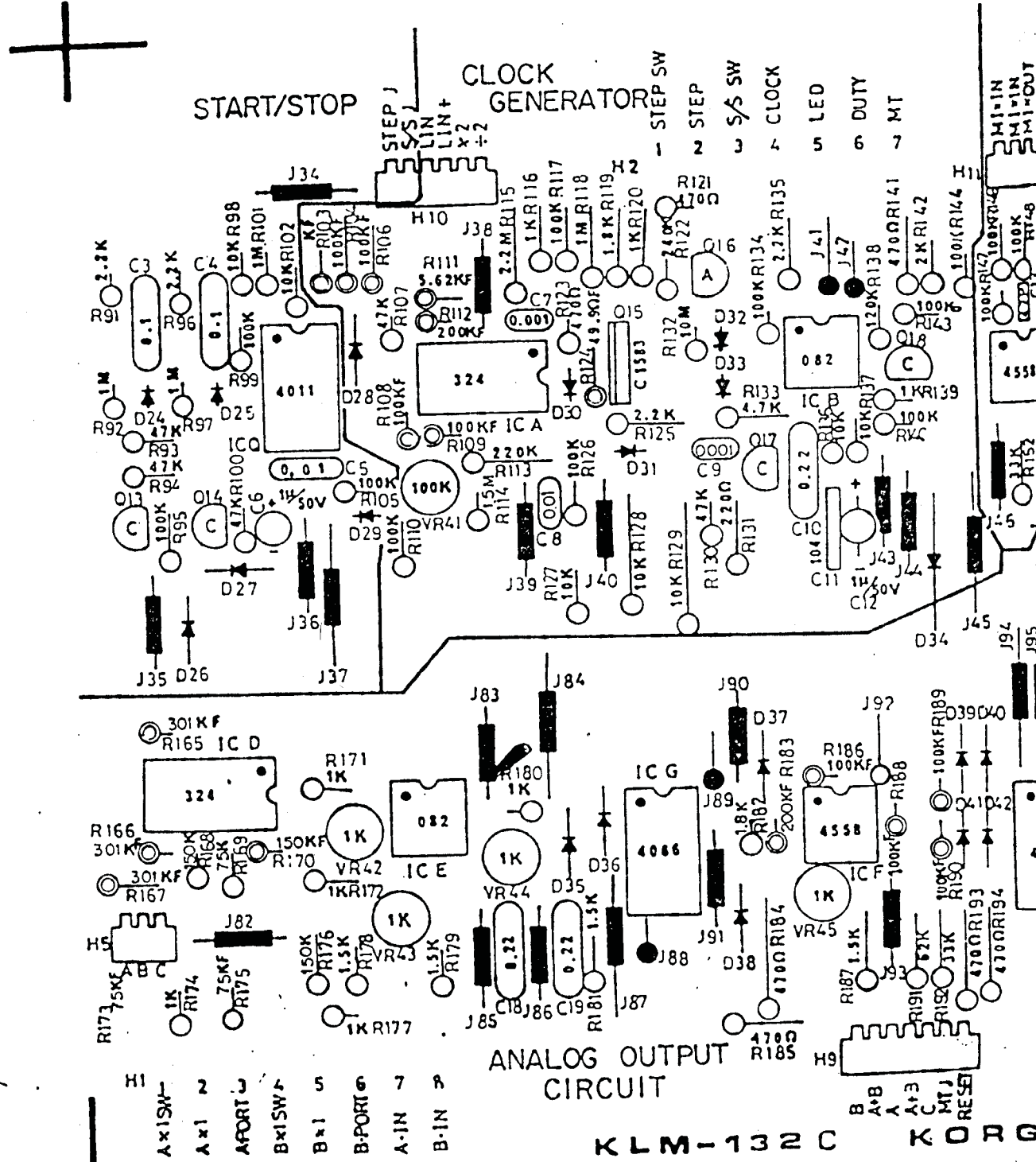

KLM-132C KODG



3010 KLM-133A

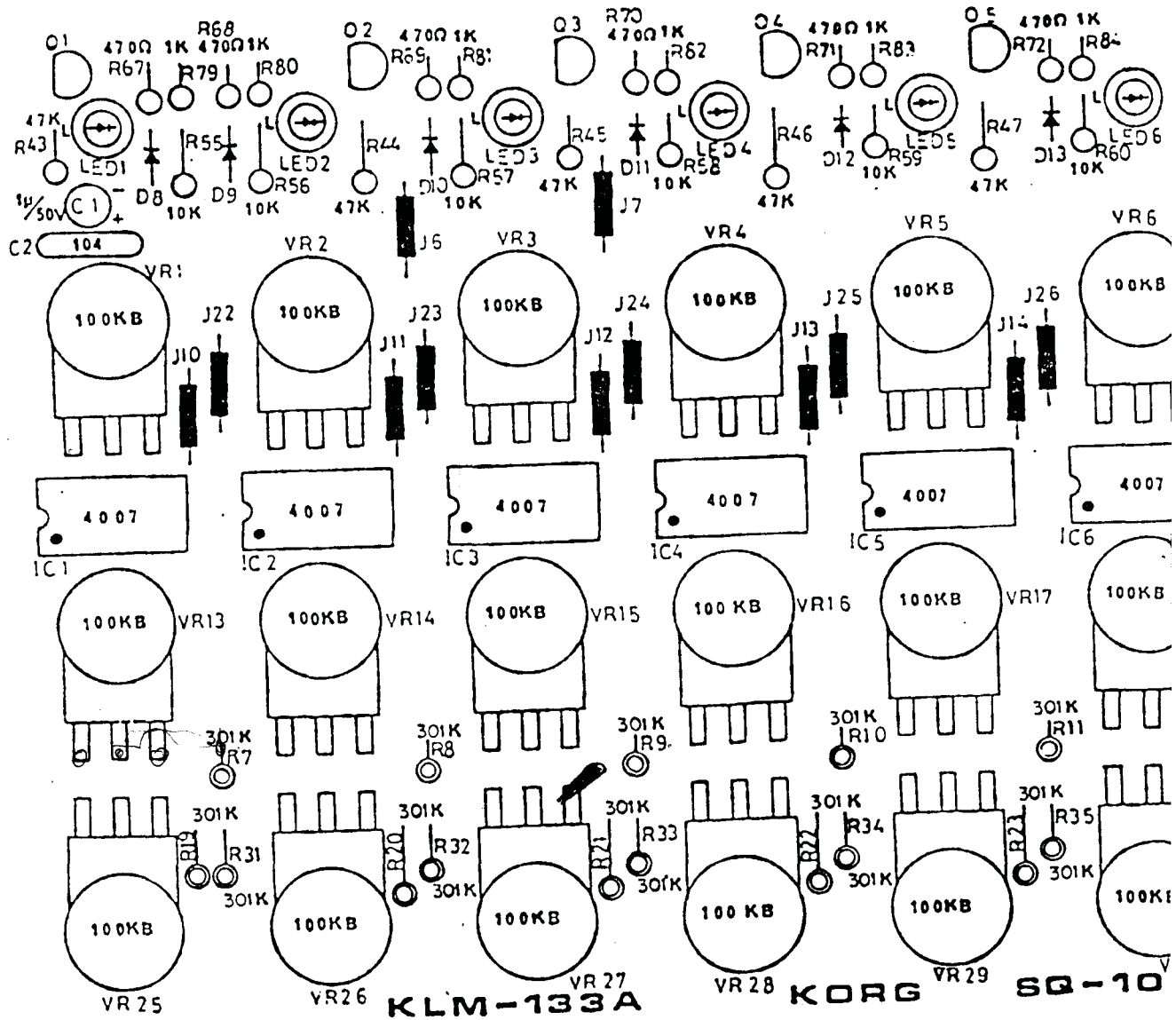

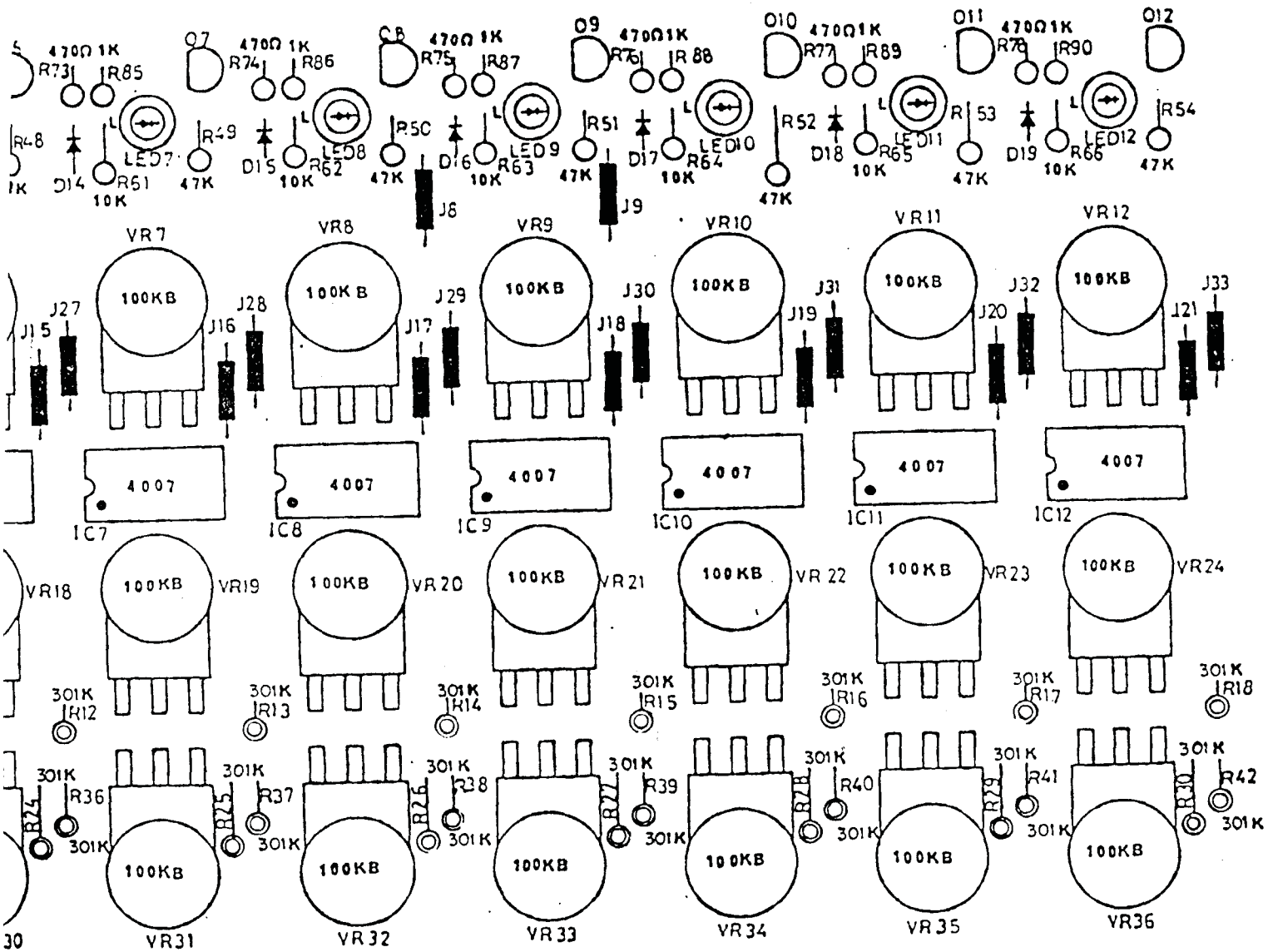

= 5SC-16P5

50-10		KLM-133A	
京王技研工業株式会社		KOD-F10004	

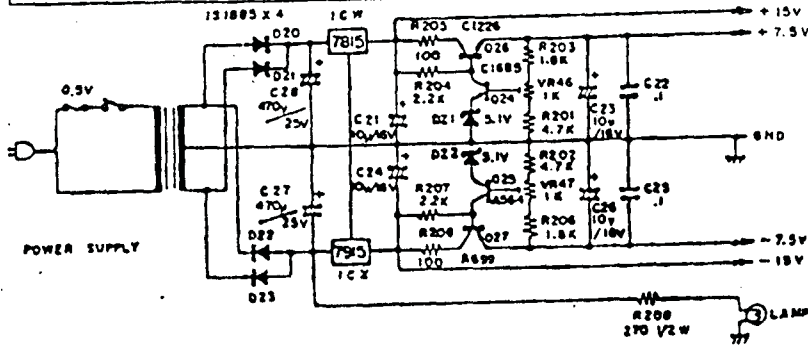
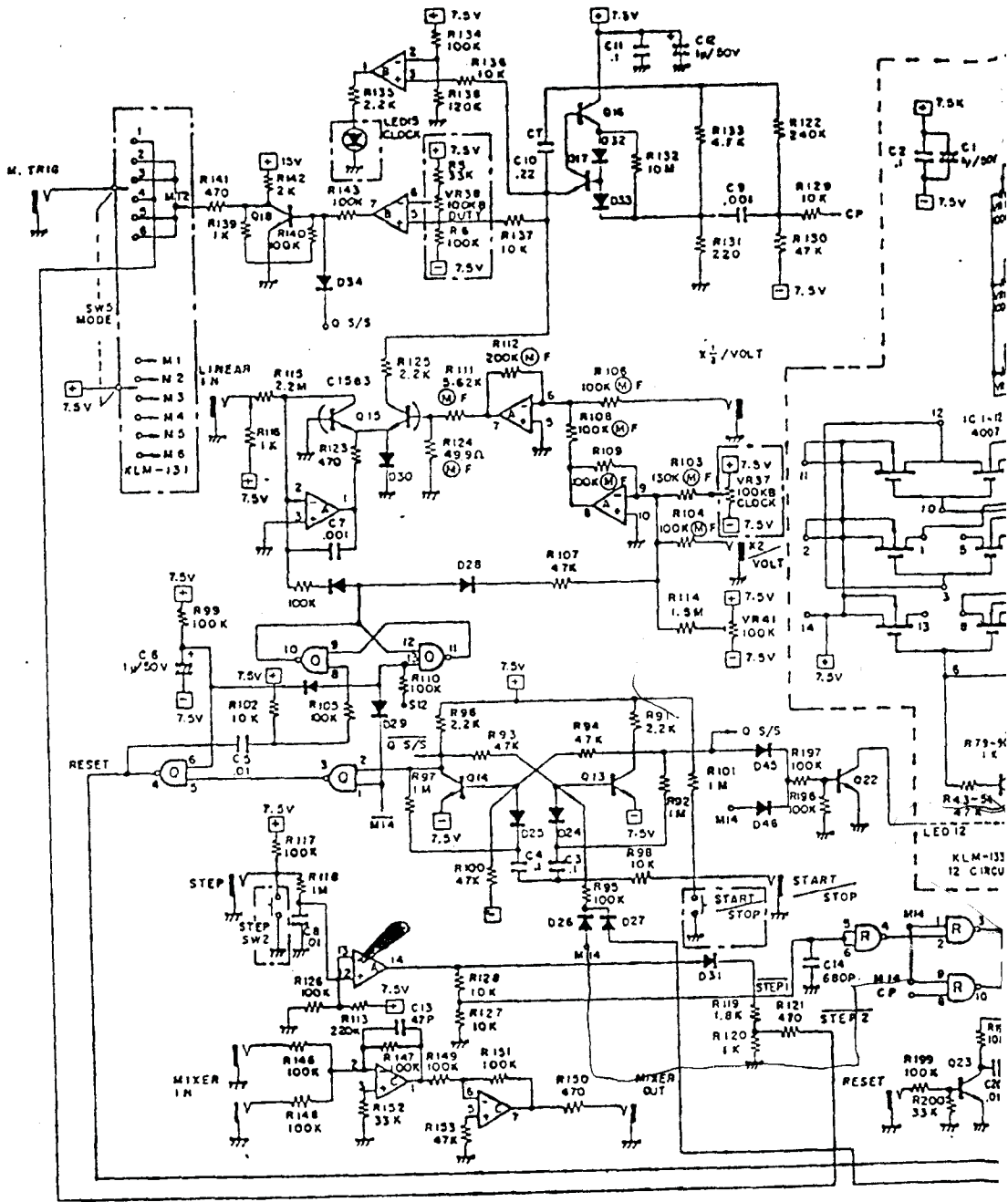

IC CHART			
NO.	OP.	CHOS.	
1		334	022
2			

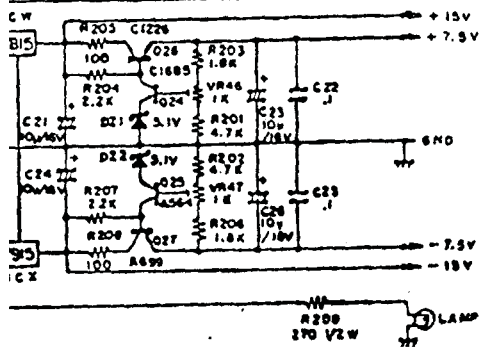
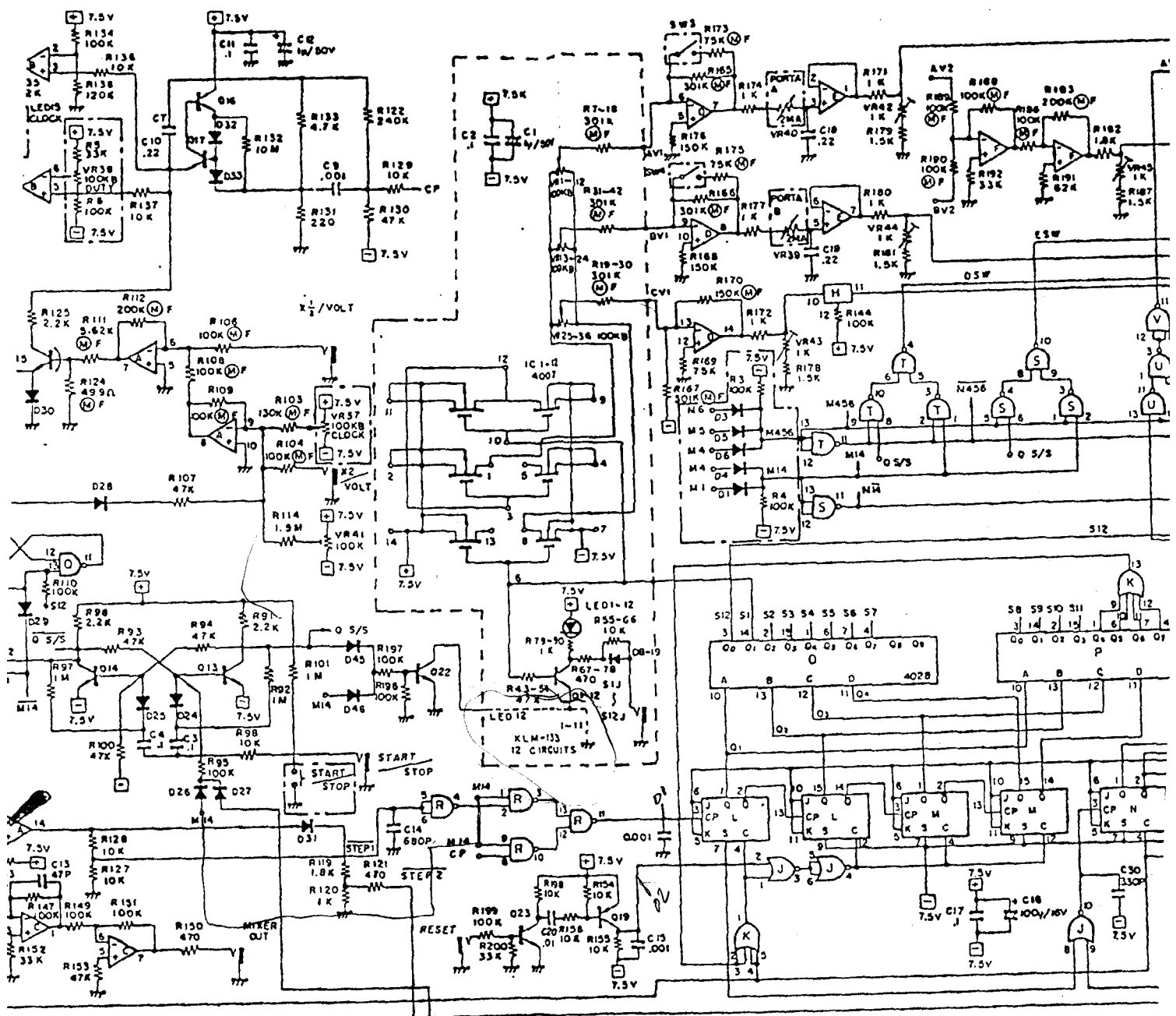

KLM132: MAIN CIRCUIT BOARD  
 KLM133: SEQUENCE CIRCUIT BOARD  
 KLM131: CONTROL CIRCUIT BOARD

\* 2SA564 PNP  
 \* 2SC1683 NPN  
 OP Amp : 2.5V  
 ANALOG SW : 7.5V  
 DIGITAL IC : 2.7.5V

IC CHART	NO.	OP	CNOS
A	34		
B	022		
C	038		
D	021		
E	021		
F	021		
G	021		
H	021		
I	021		
J	021		
K	021		
L	021		
M	021		
N	021		
O	021		
P	021		
Q	021		
R	021		
S	021		
T	021		
U	021		
V	021		
W	021		
X	021		
Y	021		
Z	021		
1	007		



